

VANLINE
BY PÖSSL GROUP



REDISCOVER THE COMPACT BUS CLASS



5 MODELS TO FALL IN LOVE WITH

VANs to give you more? When it comes to choosing, the only choice is VANLINE. Citroën or Mercedes, combustion or electric engine, permanently mounted furniture plus kitchen (swivel-mounted) or Campbox - the PÖSSL GROUP's Vanline has everything the Camper enthusiast's heart could desire.

e-VANSTER!

VANSTER!

CAMPSTER!

Vanst★r

Campst★r





THE VANLINE

A STORY OF CAMPERVAN SUCCESS

5 strong characters for an unforgettable travel experience

It all began back in 2016, when the camper world first glimpsed the CAMPSTER with its Citroën Spacetourer base. This heralded the start of Pössl's successful era as a camping van maker. With the VANSTER - also available with a Peugeot Traveller base - came a light-weight version featuring the Campbox as an alternative to fully furnished models with a permanently installed kitchen..

In 2021, with the CampStar and VanStar models, the Pössl Group introduced two new brightly shining stars to the camping van scene.

With the Mercedes V Class and Vito Tourer Pro based versions, the Pössl Group continued the tried and trusted fully-fitted camping van concept: with a large panorama pop-top roof, permanently installed furniture and swivel-mounted Easy Move Kitchen on the one hand, and the Campbox on the other, the camping experience now knows no limits.

And that's not all: if you want to go green, then look no further than the e-VANSTER! With the first ever electric-powered camping van, Pössl is setting a new milestone.

By embarking on the path that creates it. And we are blazing the trail to e-mobility camping for our customers.

Robert Hein,
Camping Van Product Development



THE VANLINE SUCCESS STORY



2016 // THE VANLINE STORY BEGINS

With the CAMPSTER – featuring a Citroën Spacetourer base, fully-fitted furniture and pop-top roof - PÖSSL makes a triumphant entry into the compact bus class.



2017 // THE PÖSSL GROUP GROWS

A new production company, H-Line Produktion GmbH, is established in Vielbrunn/Odenwald. As a result, a modern production centre is created on some 50,000 m² of space - the Vanster is built here starting in 2019, followed later by the Vanstar and Campstar.



2020 // THE VANLINE BEGINS

The season starts with the launch of the VANSTER – in contrast to the CAMPSTER, rather than having permanent furnishings, it is the perfect everyday run-about with up to eight seats, a pop-top roof and optional Campbox with cooking and sleeping facilities. The same year sees the première of both full conversion models with Mercedes Vito and V Class base: VANSTAR and CAMPSTAR join the team with the other two vans. The VANLINE range is created – the PÖSSL GROUP's compact bus class.



2021 // THE SECOND PRODUCTION CENTRE

The Dachwig plant close to Erfurt, goes into operation. Here the e-VANSTER and VANSTER are produced with the latest state-of-the-art laser-cut cabs.



2022 // PÖSSL GROUP AND E-MOBILITY

The demand for electrically-powered motorhomes grows – The PÖSSL GROUP responds by launching the e-VANSTER, the first fully-electrical model, on the market.





OUR MODELS PRESENTING A STYLISH APPEARANCE EVERYWHERE



e-VANSTER! **VANSTER!**

Page 10-17

THE (E)-VAN WITH MORE

Because whatever you're doing right now – with its versatility, it's the perfect companion for day-to-day living and recreational time.



CAMPSTER!

Page 10-11 / 18-23

THE ONE FOR ALL

The CAMPSTER is a vehicle for living. It opens up boundless possibilities to do everything a modern automobile can do.



Vanst★r

Page 24-33

THE ALL-ROUND VAN WITH A STAR

The VANSTAR is aptly named: Take the kids to football training, or on a four-week travel adventure – everything's possible, nothing's a must.



Campst★r

Page 24-25 / 34-41

THE STAR THAT CAN DO EVERYTHING

The CAMPSTAR will enthrall you with its multi-functionality and individually selectable equipment options. It makes every trip and journey a unique experience.

TWO OF A KIND

In their own special way, the (e-)VANSTER and CAMPSTER provide you with everything you need day-to-day, on weekend trips or for going away on holiday. What are you waiting for?

e-VANSTER!

VANSTER!

CAMPSTER!



■ ELEGANT EXTERIOR

With its flowing lines and body-colour bumpers, side rubbing strips, and door handles as well as 17" light alloy wheels with summer tyres (as standard), your VANSTER and CAMPSTER exudes safety, agility and elegance.

■ TWO SLIDING DOORS

Your bus is open for anything and from every side. The two large sliding doors are not merely practical, they also turn every stop into an open-air event.

■ CLEAR TO ENTER EVERY MULTI-STOREY CAR-PARK

At just 1.99 m high (height may differ if vehicle is replated for greater weight), your bus can enter any conventional multi-storey car-park without risking frontal impact to the roof. An advantage that not every vehicle in this category can offer.

■ SUPERB HANDLING

The outstanding suspension ensures optimum driving comfort and excellent steering precision, whatever the road.

■ SAFE ON THE ROAD

Your VANSTER and CAMPSTER already comes with numerous safety systems as standard:

- Vision pack (rain sensor, light sensor, automatic dimming rear-view mirror)
- LED daytime running lights
- ABS & ESC
- driver fatigue detector
- and lots more ...

■ SEPARATELY OPENING REAR-WINDOW

The separately opening rear-window means that individual items can be quickly stowed in the luggage compartment. Exceptionally practical whenever there's not enough space to open the tailgate.

■ ALMOST LIKE AT HOME

Onboard, the elevated onboard seat position and ultra-variable, comfy interior with up to 4 berths* below and in the roof above create a feeling of being inside your own four walls.

NOW eLECTRIC TOO

E-VANSTER FACTORY-FITTED WITH:

- RCC audio system with DAB with Bluetooth hands-free unit, USB
- Auxiliary air conditioning in rear
- Swivel driver and passenger seats
- Flip-up induction hob in the tail garage and a 220 V CEE external power socket

ADDITIONAL STANDARD EQUIPMENT

- Mode 2 charging cable
- Parking assist with camera
- Tinted windows
- 75 kWh battery
- Citroën Connect Box

INTELLIGENT POWER CONSUMPTION DISPLAY



75 KWH BATTERY CAPACITY



RECUPERATION FOR CHARGING WHILE DRIVING



ELECTRIC PARKING BRAKE (E-VANSTER)



BLIND-SPOT DETECTION SYSTEM*



AUTOMATIC HIGH BEAM ASSISTANT*



TRAFFIC SIGN RECOGNITION*



ATTENTION ASSIST*



LANE DEPARTURE WARNING*



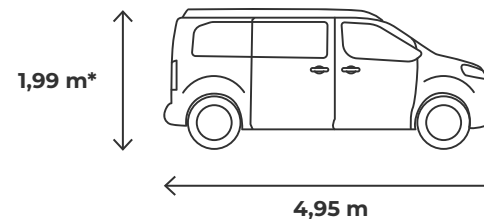

HIGHLIGHTS

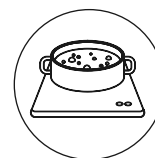

INDUCTION HOB

Flip-up induction hob in the tail garage and a 230 V CEE external socket as standard equipment.



POP-TOP ROOF

A large-sized pop-top roof with quality comfort mattress is a permanent feature. That means there's nothing stopping you from the weekend getaway.

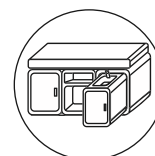

CAMPBOX KITCHEN/SLEEP

Contains everything you'll need. The practical Campbox comes in two versions for the VANSTER: in the Kitchen version with cooking and dishwashing facility, or the Sleep version with an extra bed for 2 persons.

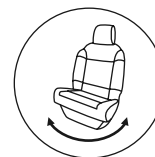

SWIVEL SEATS

The swivel, adjustable pilot seats are not just extremely comfortable, they are also great when you need to take a break and transform the interior into a living space.

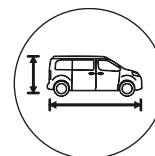

COMPACT SIZE

1.99 m high, 1.92 m wide and 4.95 m long, the VANSTER is more manoeuvrable than practically any other bus, and can also be parked in any underground car-park.

Citroën

e-VANSTER!

Peugeot
Citroën

VANSTER!

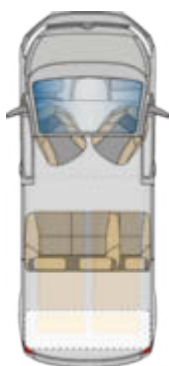

THE (E)BUS WITH A PLUS

It's like the VANSTER is tailor-made for every situation in your life. Whether it's doing the weekly shop, transporting bulky items, heading off to the countryside with bikes onboard, or – thanks

for the practical lifting roof with sleeping berth – going on a spontaneous camping trip over a long weekend. The VANSTER has something for everyone. Simply more van for less money.

* (height) may differ if vehicle is replated for greater weight



HIGHLIGHTS IN DETAIL

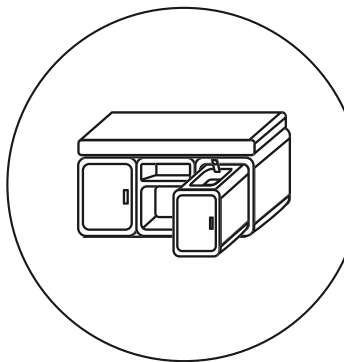

CAMPBOX

CAMPBOX SLEEP

Also features a bed system and quality comfort mattress with plate slatted frame (optional; subject to availability)





CAMPBOX KITCHEN

Comes with practical pull-out elements, 2-burner hobs and sink. The easily insertable/removable box system transforms every VANSTER into the perfect motorhome in no time.

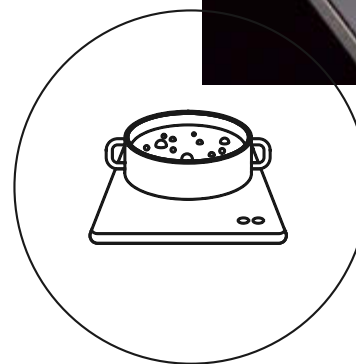

INDUCTION HOB

NOW YOU'LL ALWAYS BE THE CHEF DE LA CUISINE

The VANSTER is equipped with an induction hob and a 230 V CEE external socket as standard. With this, you can prepare every meal in a jiffy.

CAMPBOX MADE FROM CPL FINISHED TIMBER

A genuine alternative and is optically perfect inside the vehicle (subject to availability).

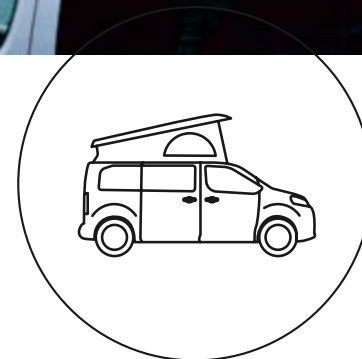

POP-TOP ROOF

POP-TOP ROOF

The VANSTER pop-top roof means you can easily set up your bed anywhere you want. The comfortable bed space is made for snuggling up and relaxing together.

Citraën	e-VANSTER!	2.0 l BlueHDI Start/Stop 145	2.0 l BlueHDI Start/Stop 180 EAT8	e-Vanster
	Citraën Peugeot	VANSTER!		
TECHNICAL DATA	Basic chassis	Citraën Spacetourer/ Peugeot Traveller	Citraën Spacetourer/ Peugeot Traveller	Citraën ë-Spacetourer
	Emission standard	Euro 6D-ISC-FCM	Euro 6D-ISC-FCM	-
	Power, kW (HP)	106 (145)	130 (177)	100 (136)
	Transmission	6-speed manual	8-speed automatic	-
	Top speed	170 km/h	170 km/h	130 km/h
	Length (m)	4.95	4.95	4.95
	Width (m)	1.92	1.92	1.92
	Height (m)	1.99	1.99	1.99
	Gross vehicle weight (kg)	3,100	3,000	3,100
	Mass in running order (kg)	1,979	2,025	2,326
	Maximum recommended load (kg)	821	775	774
	Seats (standard/optional)	Not known at time of going to print	Not known at time of going to print	5
	Berths (standard/optional)	2/4	2/4	2/4
	Towing capacity, braked (kg)	1,900	1,900	1,000
	Fuel tank (litres)	70	70	75 kWh
	Standard tyres 17"	215/60 R17C 104H	215/60 R17C	225/55 R17 101V
	Fuel economy ¹⁾			
	Urban (l/100 km)	7.7	8.0	Electric range 298 km
	Extra-urban (l/100 km)	6.8	6.9	Electric range, urban 382 km
	Combined (l/100 km)	7.2	7.6	Electrical power consumption 283 Wh/km
CO ₂ emissions, combined (g/km)	203	209	Urban power consumption 210 Wh/km	
Efficiency category ²⁾	A	A	-	

1) Fuel economy and CO₂ emissions have been determined according to the new Worldwide Harmonized Light Vehicles Test Procedure (WLTP). The more realistic test conditions mean these are frequently higher than the figures measured according to the NEDC method. To maintain comparability with vehicles measured according to the previous test method (the NEDC), the values correlated to the NEDC standard are shown in accordance with the current regulations. Please note that from 1 September 2018, taxes and other possible vehicle-related charges will be assessed based on the figures calculated according to the WLTP. It is therefore possible that the assessment of these taxes and charges will be based on figures different from those stated here. Please consult your authorised dealer for details of your vehicle's WLTP-based CO₂ emissions applied for calculating your vehicle taxes. Fuel economy and weights are always based on the series version and will change depending on the equipment selected.

2) Efficiency classes are used to rate vehicle CO₂ emissions based on the vehicle's kerb weight. Vehicles that correspond to the average are rated D. Vehicles that are better than the current average are rated E, F or G..



HIGHLIGHTS

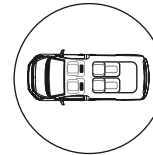

2-SEATER BENCH/BED

It's all there – with 2-seater bench/bed and flexibly adjustable single seat as standard.



PANORAMA POP-TOP ROOF

A large pop-top roof with quality comfort mattress is a permanent feature. That means there's nothing stopping you from the weekend getaway.



MOBILE KITCHEN UNIT

Supplied as standard, the kitchen unit is a removable unit providing storage space for all your cooking utensils.

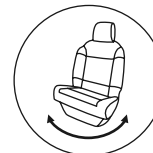

SWIVEL SEATS

The swivel, adjustable pilot seats are not just extremely comfortable, they are also great when you need to take a break and transform the interior into a living space.

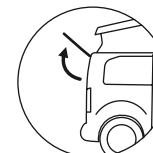

OPENING REAR-WINDOW

The separately opening rear-window means that individual items can be quickly stowed in the luggage compartment. Exceptionally practical whenever there's not enough space to open the tailgate.

Citroën

CAMPSTER!



THE ONE FOR ALL

Like the VANSTER, the CAMPSTER: As variable as life itself. But all told, even more tailored for the great, wide world. It caters to every adventurous soul with its furnishings and interior design, not forgetting the removable kitchen* and the sleeping berth

in the rear as standard. And thanks to its numerous options such as the auxiliary heating system, cool box and much more besides, the CAMPSTER can be transformed into a compact, yet super comfy motorhome ready for long road trips.

* When driving, the kitchen must be properly secured in place in the vehicle
 ** (height) may differ if vehicle is replated for greater weight



CAMPSTER!

HIGHLIGHTS IN DETAIL



PANORAMA POP-TOP ROOF

SIMPLY ENJOY A GOOD NIGHT'S SLEEP

Whether up top in the raised roof with panorama window fitted as standard (bed dimensions 1,900 x 1,100 mm) or down below. That's how heavenly it is to sleep in the CAMPSTER.



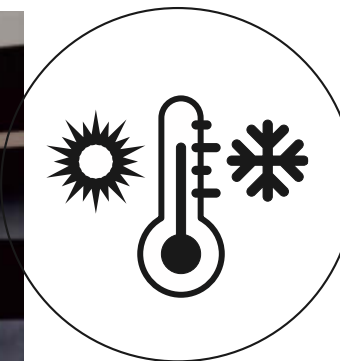

EVERYTHING AT A GLANCE

SEPARATE CONFIGURATION OPTIONS

Control panel, climate control, and auxiliary heater - easy to access, simple to use

BED EXTENSION

EVERYTHING HAS ITS PLACE

Bed extension stowable under the bench seat.



COOKING

PRACTICAL SOLID COVER

The stainless steel sink and hob can be completely covered and combined with the inside table to create a convivial dining table.



COOLING

INTEGRATED COOLING SOLUTION

Cool-box integrated into furnishings.

More sleeping space



Practical sleeping area



Dinner for 2 – or for 3 or 4



FOLDABLE 2-SEATER BENCH/ SLEEPING BERTH

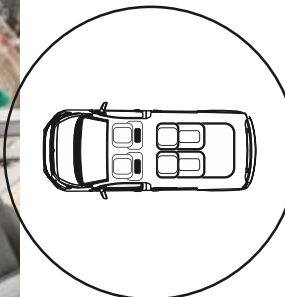

Citroën		CAMPSTER!		
		2.0 l BlueHDI Start/Stop 145	2.0 l BlueHDI Start/Stop 180 EAT8	
TECHNICAL DATA	Basic chassis	Citroën Spacetourer	Citroën Spacetourer	
	Emission standard	Euro 6D-ISC-FCM	Euro 6D-ISC-FCM	
	Power, kW (HP)	106 (145)	130 (177)	
	Transmission	6-speed manual	8-speed automatic	
	Top speed	170 km/h	170 km/h	
	Length (m)	4.95	4.95	
	Width (m)	1.92	1.92	
	Height (m)	1.99	1.99	
	Gross vehicle weight (kg)	3,100	3,000	
	Mass in running order (kg)	2,255	2,295	
	Maximum recommended load (kg)	505	505	
	Seats	4	4	
	Berths	4	4	
	Towing capacity, braked (kg)	1,900	1,900	
	Fuel tank (litres)	70	70	
	Standard tyres 17"	215/60 R17C	215/60 R17C	
	Fuel economy¹⁾			
	Urban (l/100 km)	7.7	8.0	
	Extra-urban (l/100 km)	6.8	6.9	
	Combined (l/100 km)	7.2	7.6	
CO ₂ emissions, combined (g/km)	203	209		
Efficiency category ²⁾	A	A		

1) Fuel economy and CO₂ emissions have been determined according to the new Worldwide Harmonized Light Vehicles Test Procedure (WLTP). The more realistic test conditions mean these are frequently higher than the figures measured according to the NEDC method. To maintain comparability with vehicles measured according to the previous test method (the NEDC), the values correlated to the NEDC standard are shown in accordance with the current regulations. Please note that from 1 September 2018, taxes and other possible vehicle-related charges will be assessed based on the figures calculated according to the WLTP. It is therefore possible that the assessment of these taxes and charges will be based on figures different from those stated here. Please consult your authorised dealer for details of your vehicle's WLTP-based CO₂ emissions applied for calculating your vehicle taxes. Fuel economy and weights are always based on the series version and will change depending on the equipment selected.

2) Efficiency classes are used to rate vehicle CO₂ emissions based on the vehicle's kerb weight. Vehicles that correspond to the average are rated D. Vehicles that are better than the current average are rated A+, A, B or C. Vehicles that perform below the current average are rated E, F or G..

REACH FOR THE CAMPING BUS STARS

Automotive pioneer Mercedes joins forces with PÖSSL, the motorhome pioneer. With its Vito Tourer Pro and V Class models, Mercedes delivers high standards of safety, comfort and elegance. And this is the basis on which PÖSSL VANLINE's embarks on a whole new era of freedom in personalised daily and recreational mobility – VANS that can become stars?

Vanstar

Campstar



ELEGANT EXTERIOR

The huge selection of available options means you can configure your VANSTAR and CAMPSTAR with Vito Tourer and V Class base just the way you want: Classically refined, extreme luxury, sporty elegance – what's your type?

TWO SLIDING DOORS (OPTIONAL)

Your van is open for anything and from every side. The two large sliding doors are not merely practical, they also turn every stop into an open-air event.

CLEAR TO ENTER EVERY MULTI-STOREY CAR-PARK

At just 1.94 m high (height may differ if vehicle is replated for greater weight) your camping star can enter any conventional multi-storey car-park without risking frontal impact to the roof. An advantage shared by all the VANLINE models.

SUPERB HANDLING

Optimum driving comfort and ultimate steering precision are delivered by the series rear-wheel drive with 9G-TRONIC torque converter or the optional 4MATIC, whenever the terrain gets challenging or traction is needed on wet road surfaces. The driver can choose between "comfort", AGILITY CONTROL with selective shock-absorbing system and sports suspension for greater handling dynamics.

SAFE ON THE ROAD

Your VANSTAR and CAMPSTAR come with numerous safety systems as standard equipment:

- tyre pressure monitoring systems front and rear
- ECO start/stop function
- headlight levelling
- adaptive brake lights
- seat belt warning for driver and front-seat passenger
- driver and front-seat passenger airbags
- and much more ...

SEPARATELY OPENING REAR-WINDOW (OPTIONAL)

The separately opening rear-window means that individual items can be quickly stowed in the luggage compartment. Exceptionally practical whenever there's not enough space to open the tailgate (not available as standard or with V Class).

HOME-FROM-HOME

Onboard, the comfortable onboard seat position and ultra-variable, cosy interior with up to 4 berths* below and in the roof above create a feeling of being inside your own four walls.

VANSTAR AND CAMPSTAR ARE DELIVERED PRE-EQUIPPED FOR COMFORT

- 9C-TRONIC
- aerodynamic package
- multifunction steering wheel with trip computer
- crosswind assist
- rain sensor
- highbeam assist
- immobiliser
- hill start assist
- CRUISE CONTROL
- and much more ...

LATEST GENERATION ENGINES

High-torque, efficient 4-cylinder diesel engines delivering up to 174 kW (237 PS), and which meet the Euro 6d emissions class standards. The series aerodynamic package and Blue EFFICIENCY packages additionally enhance fuel economy and reduce CO₂ emissions.

ACTIVE BRAKE ASSIST*



BLIND SPOT ASSIST*



HIGHBEAM ASSIST PLUS*

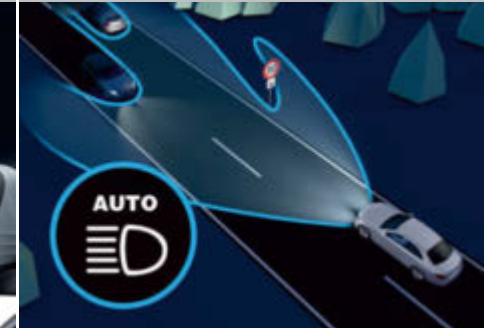

360° CAMERA*



TRAFFIC SIGN ASSIST*



DISTRONIC* ACTIVE DISTANCE CONTROL ASSIST*



DIGITAL REAR-VIEW MIRROR*



URBAN GUARD VEHICLE PROTECTION*



LANE DEPARTURE WARNING*



* optional

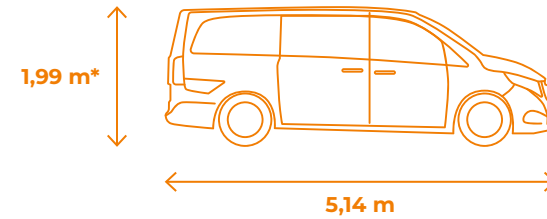

REDISCOVER YOUR WORLD

The VANSTAR is an all-round professional: Not just for joining you on every spontaneous excursion and adventure, but also as a loyal companion in

your daily life. With the VANSTAR, you are getting a fully-fledged van with camping and sleeping options on top.

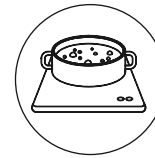

INDUCTION HOB

Flip-up induction hob in the tail garage and a 230 V CEE external socket as standard equipment.



POP-TOP ROOF

A large-sized pop-top roof with quality comfort mattress is a permanent feature. So there's nothing stopping you from the weekend getaway.

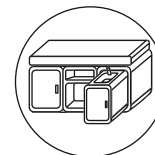

CAMPBOX KITCHEN/SLEEP

Contains everything you'll need. The practical Campbox comes in two versions: in the Kitchen version with cooking and dishwashing facility, or the Sleep version with an additional bed for 2 persons.

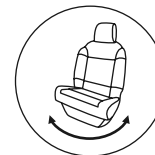

SWIVEL SEATS

The swivel, adjustable pilot seats are not just extremely comfortable, they're also great when you need to take a break and transform the interior into a living space.

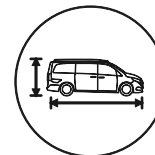

COMPACT

At 1.99 m* high, 1.93 m** wide and 5.14 m long, the VANSTAR is more manoeuvrable than practically any other bus, and can also be parked in any underground car-park.

* (height) may differ if vehicle is replated for greater weight ** excl. mirror, with mirror 2.25 m



HIGHLIGHTS IN DETAIL

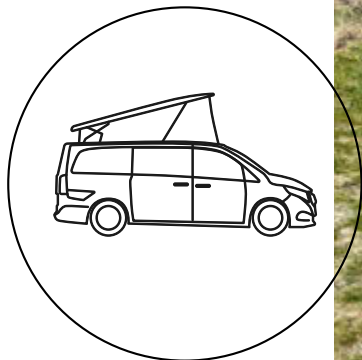

PANORAMA ROOF

SLEEPING COMFORT LIKE AT HOME

You'll sleep like you do at home in our WHOOP panorama pop-top roof: with the 110 cm wide bed area, a slatted frame and the extra thick 5-cm mattress, you're guaranteed a relaxing night's sleep. The panorama function ensures a wow moment at bedtime and again in the morning – enjoyed from the comfort of your bed. The serial lighting package delivers plenty of work light below and a comfortable ambience up top - both are dimmable, of course.



KITCHEN/SLEEP CAMP BOX

CAMPBOX KITCHEN

Comes with practical pull-out elements, 2-burner hobs and sink. The easily insertable/removable box system transforms every VANSTAR into the perfect motor-home in no time. Available as CAMPBOX KITCHEN & SLEEP with mattress

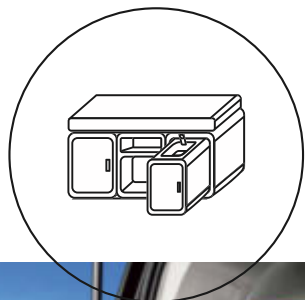

CAMPBOX LITE

With practical stackable containers, allowing the Campbox to be loaded at home. The CAMPBOX LITE KITCHEN additionally comes with a cooking and dishwashing module with fresh water and waste water tank. The CAMPBOX LITE SLEEP means you have two additional beds available. The CAMPBOX LITE KITCHEN & SLEEP offers both versions.

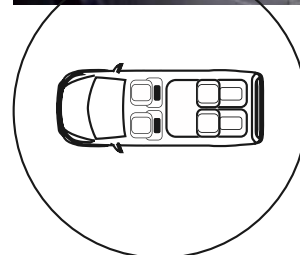

SINGLE SEATS AND BENCH

JUST THE WAY YOU WANT IT

Choose the seating you need for your daily routine. The up to 4 comfortable single seats in the V Class or a max. of two 3-person bench seats in the Vito will guarantee you a pleasant and comfortable journey.

HIGHLIGHTS IN DETAIL



HANDLES THE DAILY ROUTINE

FITS INTO EVERY GARAGE

Something you can count on. Whether you are parking your VANSTAR at home or in an underground car-park during a trip – with its compact dimensions of 1.99 m** high, 1.93 m wide and 5.14 m long, the VANSTAR will fit in no problem.

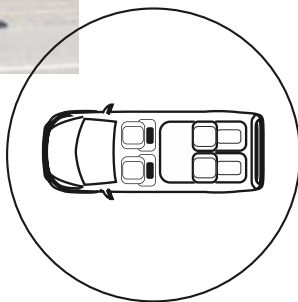

INFOTAINMENT

MBUX – THE INFOTAINMENT FROM MERCEDES IS DEFINING THE USER EXPERIENCE

This includes high-definition displays, which combine relevant driving information and central touchscreen in one control unit. Interactive elements integrate the user through voice, touch and intelligent gesture control. There are also impressive vehicle and infotainment functions as well as the possibility of arranging the user experience wholly according to personal preferences through artificial intelligence and customisation options.

* (height) may differ if vehicle is replated for greater weight



	Vito Tourer Pro	Vito Tourer Pro
Basic chassis	Vito Tourer Pro	Vito Tourer Pro
Emission standard	Euro 6D-ISC-FCM	Euro 6D-ISC-FCM
Power, kW (HP)	100 (136)	120 (163)
Transmission	Automatic	Automatic
Top speed (km/h)	183	195
Length (m)	5.14	5.14
Width (m)*	1.93	1.93
Height (m)*	1.99	1.99
Gross vehicle weight (kg)	3,100	3,100
Mass in running order	2,386	2,380
Maximum recommended load (kg)	714	720
Weight increase (kg) optional	3,200	3,200
Seats	5/8	5/8
Berths	2+2	2+2
Towing capacity, braked (kg)	0***/2,000/2,500 (optional)	0***/2,000/2,500 (optional)
Fuel tank (litres)	70	70
Standard tyres	195/65 R16	205/65 R16
* excl. mirror, with mirror 2.25 m ** may differ if vehicle is replated for greater weight *** Vito: Towing capacity = 0 kg without wiring for trailer socket (optional)		
Fuel economy*		
Urban (l/100 km)	8.2	8.2
Extra-urban (l/100 km)	6.5	6.5
Combined (l/100 km)	7.1	7.1
CO₂ emissions, combined (g/km)* approx.	190	190
Efficiency category*	B	B

* Fuel consumption and emissions data and efficiency classes are determined according to the relevant base chassis and take the selected equipment and fittings into account.

119 CDI 9G-TRONIC	124 CDI 9G-TRONIC	V 220 d 9G-TRONIC	V 250 d 9G-TRONIC	V 300 d 9G-TRONIC
Vito Tourer Pro	Vito Tourer Pro	V Class	V Class	V Class
Euro 6D-ISC-FCM	Euro 6D-ISC-FCM	Euro 6D-ISC-FCM	Euro 6D-ISC-FCM	Euro 6D-ISC-FCM
140 (190)	174 (237)	120 (163)	140 (190)	174 (237)
Automatic	Automatic	Automatic	Automatic	Automatic
205	220	195	205	220
5.14	5.14	5.14	5.14	5.14
1.93	1.93	1.93	1.93	1.93
1.99	1.99	1.99	1.99	1.99
3,100	3,100	3,100	3,100	3,100
2,388	2,396	2,382	2,380	2,380
712	704	718	720	720
3,200	3,200	3,200	3,200	3,200
5/8	5/8	4/6	4/6	4/6
2+2	2+2	2+2	2+2	2+2
0***/2,000/2,500 (optional)	0***/2,000/2,500 (optional)	2,000/2,500 (optional)	2,000/2,500 (optional)	2,000/2,500 (optional)
70	70	70	70	70
225/55 R17	235/55 R17	205/65 R16	225/55 R17	235/55 R17
8.2	8.2	8.2	8.2	8.2
6.5	6.5	6.5	6.5	6.5
7.1	7.1	7.1	7.1	7.1
209	213	200	209	213
B	B	A	B	B

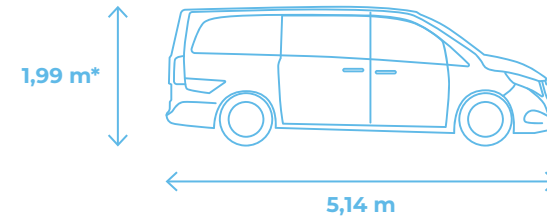

HIGHLIGHTS

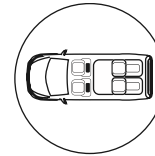

2-SEATER BENCH/BED

It's all there – with 2-seater bench/bed and optional additional single seat.



PANORAMA POP-TOP ROOF

A large pop-top roof with quality comfort mattress is a permanent feature. So there's nothing stopping you from the weekend getaway.

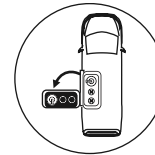

EASY MOVE KITCHEN

The last word in camper kitchen convenience. A swivel mechanism means the CAMPSTAR Easy Move Kitchen can be swung out from the vehicle with a flick of the wrist, and placed on the ground using the telescopic leg. So, you'll be ready to start cooking outdoors in no time at all with the gas hobs and stainless steel basin.

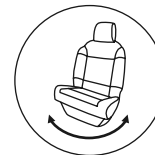

SWIVEL SEATS

The swivel, adjustable pilot seats are not just extremely comfortable, they're also great when you need to take a break and transform the interior into a living space.

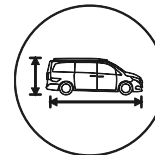

COMPACT

At 1.99 m* high, 1.93 m** wide and 5.14 m long, the CAMPSTAR is more manoeuvrable than practically any other bus, and can also be parked in any underground car-park.

Mercedes-Benz

Campstar

SURE TO DAZZLE THE EYES

A shining star in the camping bus skies. The CAMPSTAR combines the sleek elegance and dynamism of the Mercedes Vito Tourer and V Class with the

familiar innovative camping pedigree of Pössl. As a symbiosis of both these pioneers, the CAMPSTAR leaves nothing to be desired. See for yourself!

* (height) may differ if vehicle is replated for greater weight
** excl. mirror, with mirror 2,25 m



HIGHLIGHTS IN DETAIL



2-SEATER BENCH/ SLEEPING BERTH

JUST THE WAY YOU WANT IT

The CAMPSTAR'S 2-seater bench/sleeping berth can be extended and retracted effortlessly. Enjoy convenient sleeping comfort and maximum flexibility when you're on the go.

SLEEP PEACEFULLY

At 5 cm, the extra-thick mattress in the panorama pop-up roof guarantees the best-possible sleeping comfort.

PANORAMA POP-TOP ROOF

SLEEPING COMFORT LIKE AT HOME

You'll sleep like you do at home in our WHOOP panorama pop-top roof: with the 110 cm wide bed area, a slatted frame and the extra thick 5-cm mattress, you're guaranteed a relaxing night's sleep. The panorama function ensures a wow moment at bedtime and again in the morning – enjoyed from the comfort of your bed. The serial lighting package delivers plenty of work light below and a comfortable ambience up top - both are dimmable, of course.

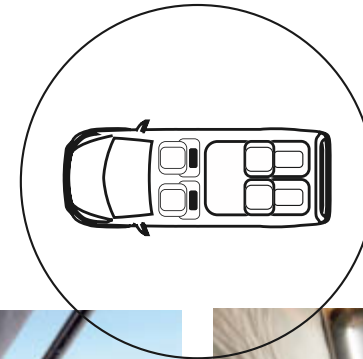



HIGHLIGHTS IN DETAIL



PLENTY OF SPACE

Generous stowage space in the locker and rear compartment.

* (height) may differ, if vehicle is replated for greater weight
 ** excl. mirror, with mirror 2.25 m

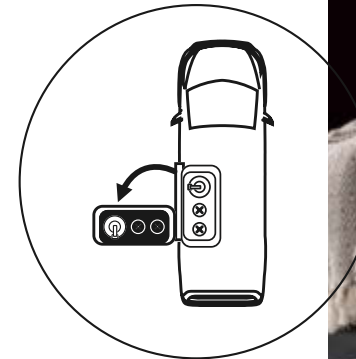

GENUINE LOUNGE-STYLE COOKING

EASY MOVE KITCHEN

The undeniable highlight of the CAMPSTAR is its Easy Move Kitchen. By opening the sliding door on the kitchen side of the vehicle, the kitchen can be swivelled outwards and placed on the surface. The swivel design means that only two hand movements are needed before you can start enjoying an out-of-doors kitchen. The top quality Easy Move Kitchen comes with gas hobs, stainless steel basin, hard cover and storage facilities. Not to mention: the ambient lighting!



HANDLES THE DAILY ROUTINE

FITS IN EVERYWHERE – AND FITS EVERYTHING IN

You can park your CAMPSTAR at home or in an underground carpark when you're on the go – and what's more, filled with everything you might need on your trip. It's not just the compact size - 1.99 m* high, 1.93 m** wide and 5.14 m long - that's unbeatable, for the interior also boasts one of the largest usable and storage spaces in its class.



TOP QUALITY FURNISHINGS

The Easy Move Kitchen is made from top quality materials and is impressively easy to operate.

PRACTICAL SOLID COVER

The stainless steel basis and hob can be completely covered.



	Vito Tourer Pro	Vito Tourer Pro
Basic chassis	Vito Tourer Pro	Vito Tourer Pro
Emission standard	Euro 6D-ISC-FCM	Euro 6D-ISC-FCM
Power, kW (HP)	100 (136)	120 (163)
Transmission	Automatic	Automatic
Top speed (km/h)	183	195
Length (m)	5.14	5.14
Width (m)*	1.93	1.93
Height (m)*	1.99	1.99
Gross vehicle weight (kg)	3,100	3,100
Mass in running order (kg)	2,455	2,455
Maximum recommended load (kg)	645	645
Weight increase (kg) optional	3,200	3,200
Seats	4	4
Berths	4	4
Towing capacity, braked (kg)	0***/2,000/2,500 (optional)	0***/2,000/2,500 (optional)
Fuel tank (litres)	70	70
Standard tyres	195/65 R16	205/65 R16

* excl. mirror, with mirror 2.25 m ** may differ if vehicle is replated for greater weight
 *** Vito: Towing capacity = 0 kg without wiring for trailer socket (optional)

Fuel economy*

Urban (l/100 km)	8.2	8.2
Extra-urban (l/100 km)	6.5	6.5
Combined (l/100 km)	7.1	7.1
CO₂ emissions, combined (g/km)* approx.	204	207
Efficiency category*	B	B

* Fuel consumption and emissions data and efficiency classes are determined according to the relevant base chassis and take the selected equipment and fittings into account.

119 CDI 9G-TRONIC	124 CDI 9G-TRONIC	V 220 d 9G-TRONIC	V 250 d 9G-TRONIC	V 300 d 9G-TRONIC
Vito Tourer Pro	Vito Tourer Pro	V Class	V Class	V Class
Euro 6D-ISC-FCM	Euro 6D-ISC-FCM	Euro 6D-ISC-FCM	Euro 6D-ISC-FCM	Euro 6D-ISC-FCM
140 [190]	174 [237]	120 [163]	140 [190]	174 [237]
Automatic	Automatic	Automatic	Automatic	Automatic
205	220	188	205	220
5.14	5.14	5.14	5.14	5.14
1.93	1.93	1.93	1.93	1.93
1.99	1.99	1.99	1.99	1.99
3,100	3,100	3,100	3,100	3,100
2,455	2,455	2,455	2,455	2,455
645	645	645	645	645
3,200	3,200	3,200	3,200	3,200
4	4	4/5	4/5	4/5
4	4	4	4	4
0***/2,000/2,500 (optional)	0***/2,000/2,500 (optional)	2,000/2,500 (optional)	2,000/2,500 (optional)	2,000/2,500 (optional)
70	70	70	70	70
225/55 R17	235/55 R17	205/65 R16	225/55 R17	235/55 R17
8.2	8.2	8.2	8.2	8.2
6.5	6.5	6.5	6.5	6.5
7.1	7.1	7.1	7.1	7.1
213	217	222	225	229
B	B	A	B	B







facebook.com/campstervanster
facebook.com/campstarvanstar



instagram.com/campster_vanster
instagram.com/campstar__vanstar



youtube.com/poesslgroup



pinterest.de/poesslgroup



vimeo.com/poesslgroup



linkedin.com/company/poesslgroup



GET IN TOUCH TODAY! VISIT US ONLINE AT [POESSL-VANLINE.DE](https://poessl-vanline.de), OR ON OUR SOCIAL MEDIA SITES, OR CALL IN WITH YOUR LOCAL AUTHORISED VANLINE DEALER.

Images: KNITTEL • danielwagnerphoto • Chris Wacker-Bauer • Dennis Schmelz
© Mercedes-Benz AG • © CITROËN COMMUNICATION

developed by papillo.de



Rights reserved concerning technical specifications and errors. Please note that illustrations in this brochure may contain decor or special equipment that are not included in the scope of delivery or for which additional charges may be incurred. Minor deviations in colour may occur due to the printing process. Updated 07/2023

* According to EC Directive 97/27 and EU standard EN 1645-2, the "mass in running order" comprises the unladen weight of the vehicle with the smallest engine size available – incl. driver (75 kg) and filled fuel tank (56 kg). The gross vehicle weight must not be exceeded when the personal equipment, persons travelling with the vehicle and any optional extras are taken into account. Installation of extras will reduce the maximum recommended load and may reduce the permitted number of persons. The information on the scope of delivery, appearance, performance, dimensions and weight of the vehicles corresponds to the knowledge available at the time of going to press, and the European homologation regulations. These can change up until the time the vehicle is purchased or until delivery. Deviations within the factory tolerances (+/- 5% max.) are possible and permissible.